



TO-251-3L/TO-252-2L Plastic-Encapsulate Regulators

CJ78M05 Three-terminal positive voltage regulator

FEATURES

- Maximum output current
I_{OM}: 0.5 A
- Output voltage
V_O: 5V
- Continuous total dissipation
P_D: 1.25 W

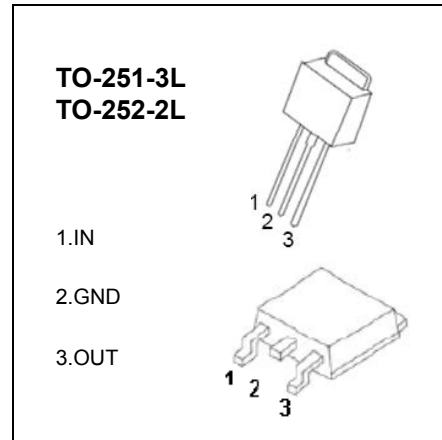

ABSOLUTE MAXIMUM RATINGS (Operating temperature range applies unless otherwise specified)

Parameter	Symbol	Value	Unit
Input Voltage	V _i	25	V
Operating Junction Temperature Range	T _{OPR}	0-+125	°C
Storage Temperature Range	T _{STG}	-65-+150	°C

ELECTRICAL CHARACTERISTICS AT SPECIFIED VIRTUAL JUNCTION TEMPERATURE (V_i=10V, I_o=350mA, C_i=0.33μF, C_o=0.1μF, unless otherwise specified)

Parameter	Symbol	Test conditions	Min	Typ	Max	Unit
Output Voltage	V _o	25°C	4.8	5	5.2	V
		7V ≤ V _i ≤ 20V, I _o = 5mA-350mA P _o ≤ 15W	0-125°C	4.75	5	5.25
Load Regulation	ΔV _o	I _o = 5mA-0.5A	25°C	15	100	mV
		I _o = 5mA-200mA	25°C	5	50	mV
Line Regulation	ΔV _o	7V ≤ V _i ≤ 25V, I _o = 200mA	25°C	3	100	mV
		8V ≤ V _i ≤ 25V, I _o = 200mA	25°C	1	50	mV
Quiescent Current	I _q	25°C		4.2	6	mA
Quiescent Current Change	ΔI _q	8V ≤ V _i ≤ 25V, I _o = 200mA	0-125°C		0.8	mA
		5mA ≤ I _o ≤ 350mA	0-125°C		0.5	mA
Output Noise Voltage	V _N	10Hz ≤ f ≤ 100KHz	25°C	40	200	μV
Ripple Rejection	RR	8V ≤ V _i ≤ 18V, f = 120Hz, I _o = 300mA	0-125°C	62	80	dB
Dropout Voltage	V _d	I _o = 350mA	25°C	2	2.5	V
Short Circuit Current	I _{sc}	V _i = 10V	25°C	300		mA
Peak Current	I _{pk}		25°C	0.5		A

TYPICAL APPLICATION

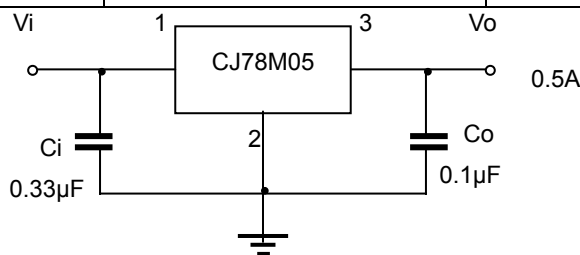

Typical Characteristics

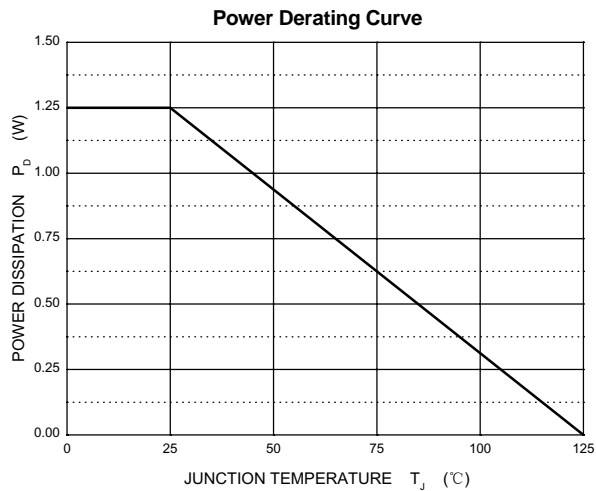
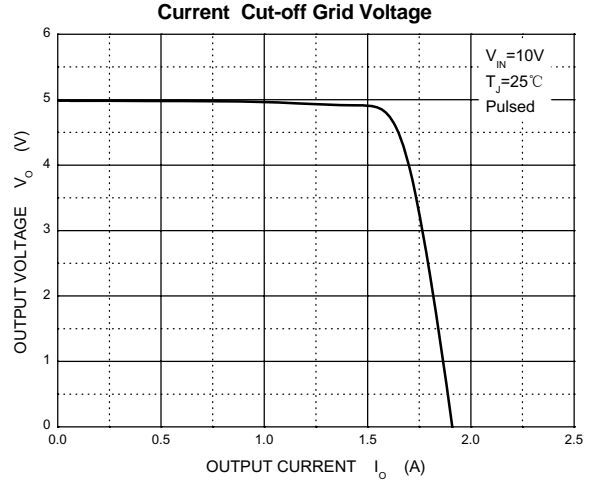
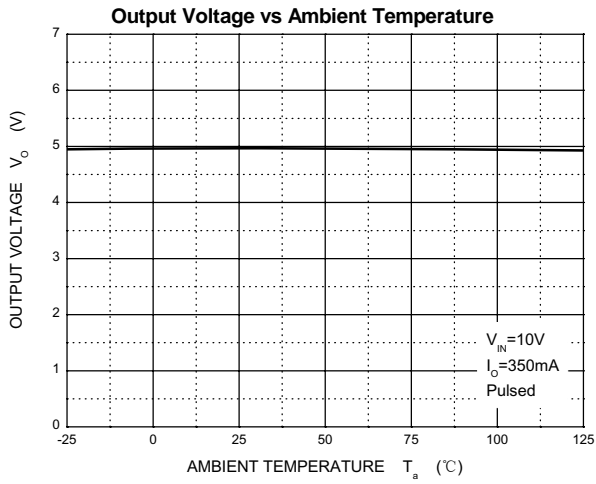
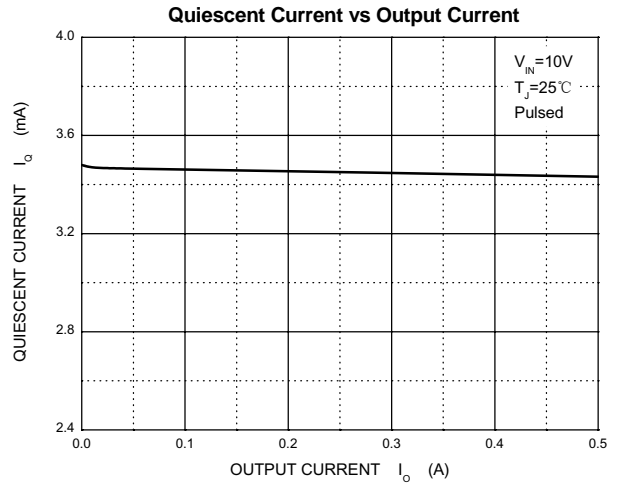
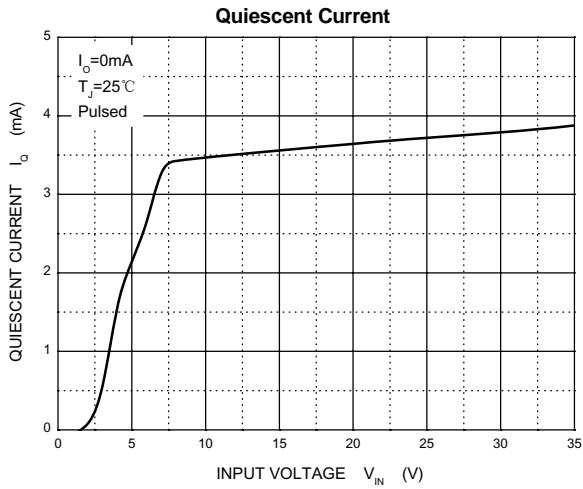
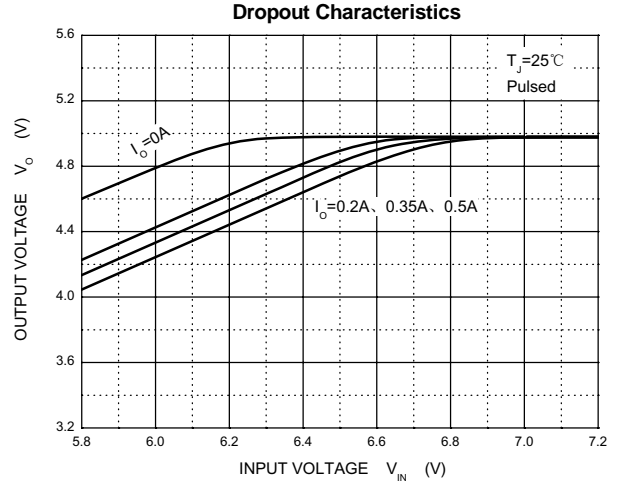
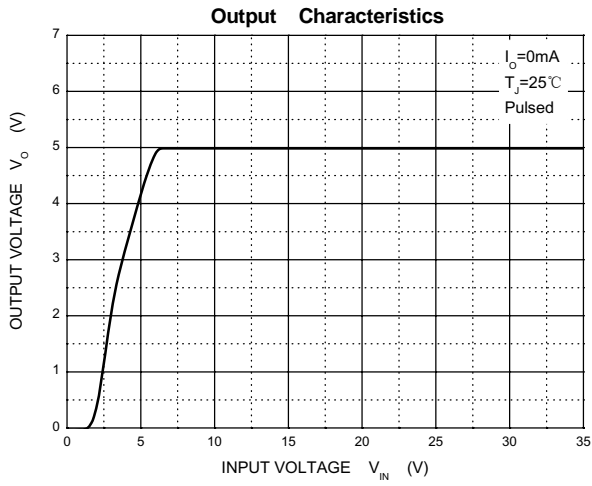

TO-251-3L Package Outline Dimensions

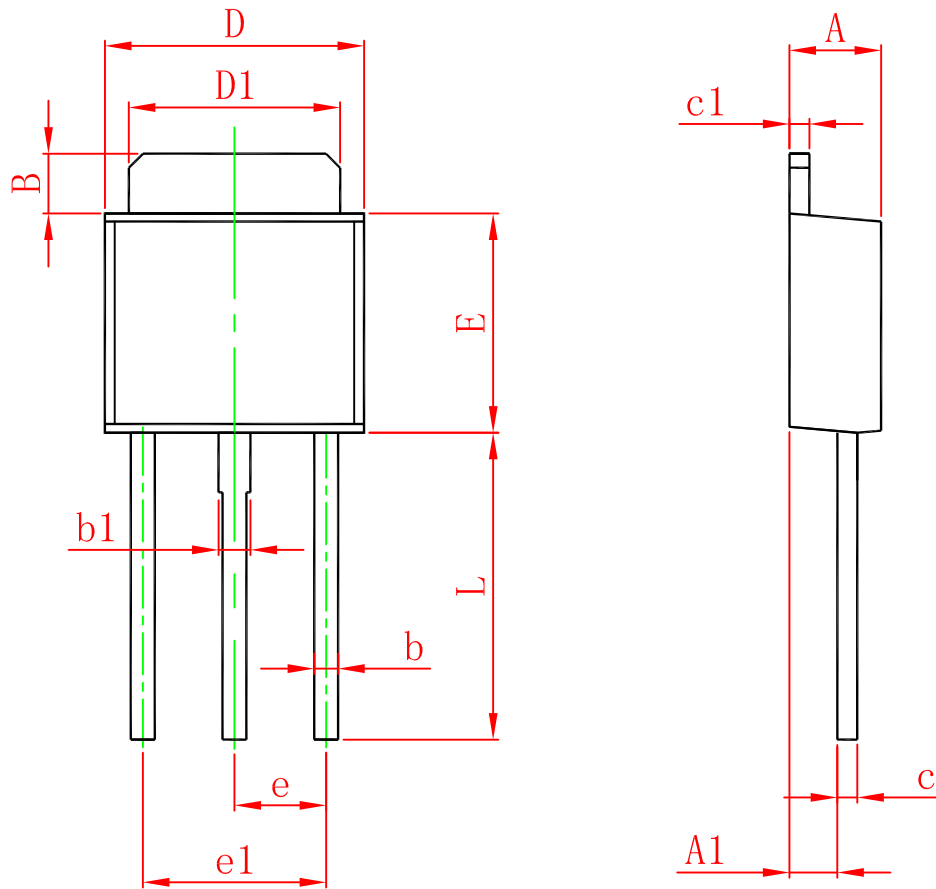

Symbol	Dimensions In Millimeters		Dimensions In Inches	
	Min.	Max.	Min.	Max.
A	2.200	2.400	0.087	0.094
A1	1.050	1.350	0.042	0.054
B	1.350	1.650	0.053	0.065
b	0.500	0.700	0.020	0.028
b1	0.700	0.900	0.028	0.035
c	0.430	0.580	0.017	0.023
c1	0.430	0.580	0.017	0.023
D	6.350	6.650	0.250	0.262
D1	5.200	5.400	0.205	0.213
E	5.400	5.700	0.213	0.224
e	2.300 TYP.		0.091 TYP.	
e1	4.500	4.700	0.177	0.185
L	7.500	7.900	0.295	0.311